

Clamps

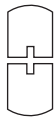

COOLEY CROSS ACTION BULLDOG CLAMP



PN1085



CODE	DESCRIPTION	LENGTH	JAW LENGTH	TEETH
PN0118	Cooley Cross Action Bulldog Clamp, Straight	80	24	Cooley
PN0592	Cooley Cross Action Bulldog Clamp, Straight	90	35	Cooley
PN1084	Cooley Cross Action Bulldog Clamp, Straight	105	50	Cooley
PN1085	Cooley Cross Action Bulldog Clamp, Straight	124	69	Cooley



PN1087

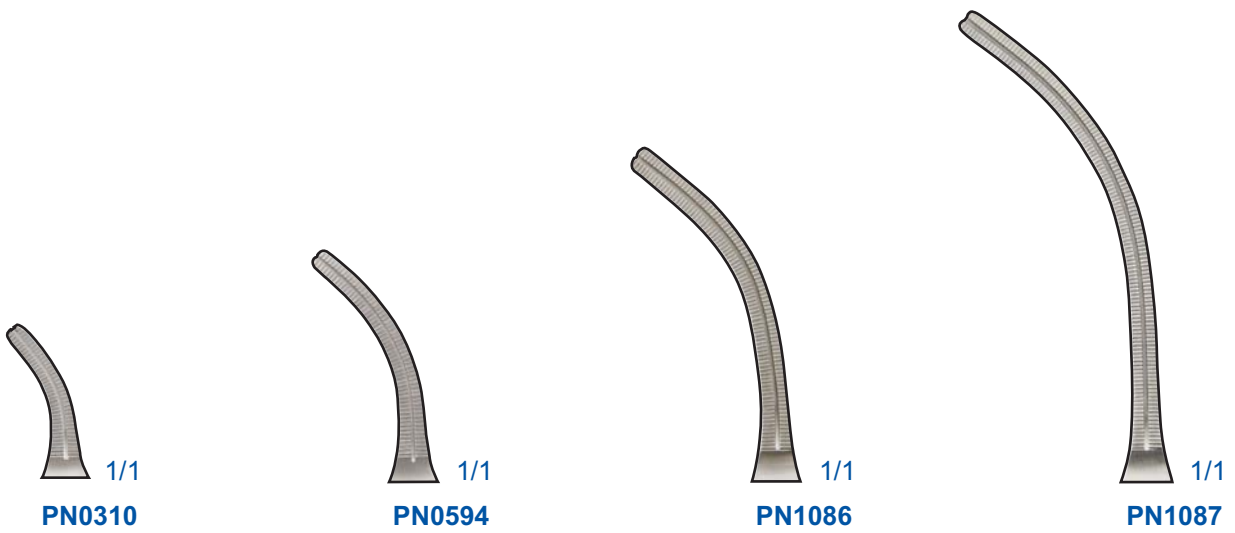

CODE	DESCRIPTION	LENGTH	JAW LENGTH	TEETH
PN0310	Cooley Cross Action Bulldog Clamp, Curved	77	20	Cooley
PN0594	Cooley Cross Action Bulldog Clamp, Curved	86	30	Cooley
PN1086	Cooley Cross Action Bulldog Clamp, Curved	98	44	Cooley
PN1087	Cooley Cross Action Bulldog Clamp, Curved	115	63	Cooley

DEBAKEY CROSS ACTION BULLDOG CLAMP



PN0591

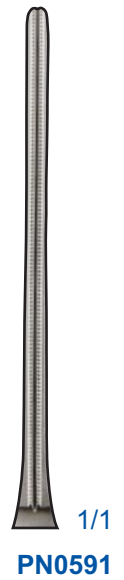
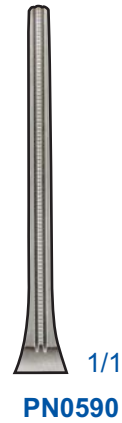

CODE	DESCRIPTION	LENGTH	JAW LENGTH	TEETH
PN0545	Debakey Cross Action Bulldog Clamp, Straight	80	24	Debakey 1 x 2
PN0309	Debakey Cross Action Bulldog Clamp, Straight	90	34	Debakey 1 x 2
PN1093	Debakey Cross Action Bulldog Clamp, Straight	100	44	Debakey 1 x 2
PN0590	Debakey Cross Action Bulldog Clamp, Straight	105	49	Debakey 1 x 2
PN0591	Debakey Cross Action Bulldog Clamp, Straight	125	69	Debakey 1 x 2



PN0599

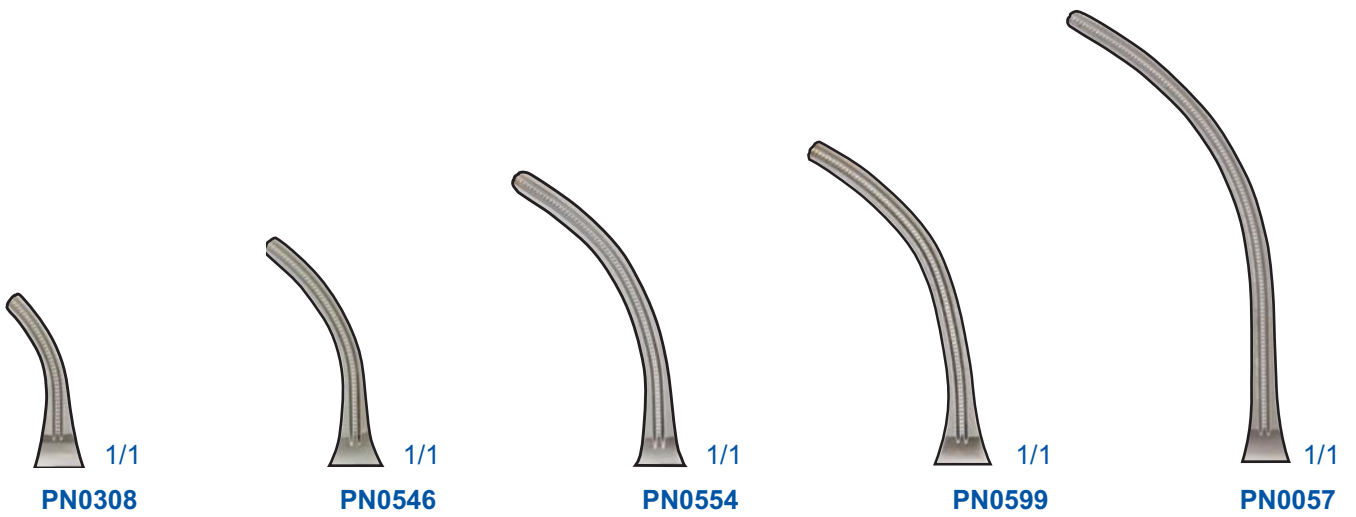

CODE	DESCRIPTION	LENGTH	JAW LENGTH	TEETH
PN0308	Debakey Cross Action Bulldog Clamp, Curved	75	22	Debakey 1 x 2
PN0546	Debakey Cross Action Bulldog Clamp, Curved	85	30	Debakey 1 x 2
PN0554	Debakey Cross Action Bulldog Clamp, Curved	95	41	Debakey 1 x 2
PN0599	Debakey Cross Action Bulldog Clamp, Curved	100	44	Debakey 1 x 2
PN0057	Debakey Cross Action Bulldog Clamp, Curved	115	63	Debakey 1 x 2

COOLEY PAEDIATRIC OCCLUSION CLAMP



PN0182



1/1

PN0181

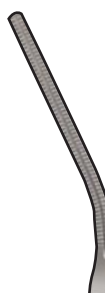

1/1

PN0183



1/1

PN0182



1/1

PN0184



1/1

PN0185

CODE	DESCRIPTION	LENGTH	JAW LENGTH	TEETH
PN0181	Cooley Paediatric Occlusion Clamp, Straight	143	37	Cooley
PN0183	Cooley Paediatric Occlusion Clamp, Angled Jaw	143	37	Cooley
PN0182	Cooley Paediatric Occlusion Clamp, Angled Shank	144	37	Cooley
PN0184	Cooley Paediatric Occlusion Clamp, Spoon Jaw	143	35	Cooley
PN0185	Cooley Paediatric Occlusion Clamp, Satinsky Jaw	140	35	Cooley



PN0550

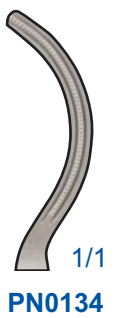

CODE	DESCRIPTION	LENGTH	JAW LENGTH	TEETH
PN1092	Debakey Paediatric Occlusion Clamp, Straight	156	38	Debakey 1 x 2
PN0550	Debakey Paediatric Occlusion Clamp, Angled Jaw	155	36	Debakey 1 x 2
PN0551	Debakey Paediatric Occlusion Clamp, Angled Shank	155	37	Debakey 1 x 2
PN0134	Debakey Paediatric Occlusion Clamp, Spoon Jaw	155	34	Debakey 1 x 2

COOLEY DERRA CLAMP



PN0318



1/1
PN0272

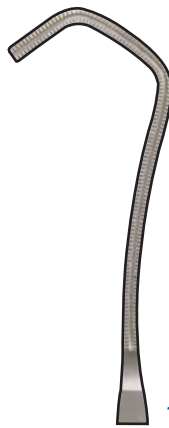

1/1
PN0336

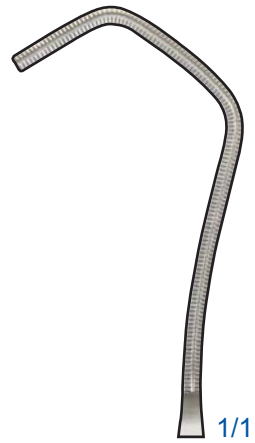

1/1
PN0318

CODE	DESCRIPTION	LENGTH	JAW LENGTH	TEETH
PN0272	Cooley Derra Clamp, Small	170	46	Cooley
PN0336	Cooley Derra Clamp, Medium	175	50	Cooley
PN0318	Cooley Derra Clamp, Large	175	53	Cooley



PN0031

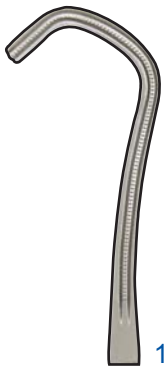

1/1

PN0029



1/1

PN0030

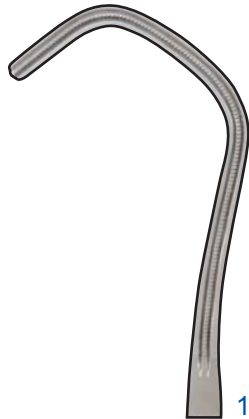

1/1

PN0031

CODE	DESCRIPTION	LENGTH	JAW LENGTH	TEETH
PN0029	Debakey Derra Clamp, Small	165	42	Debakey 1 x 2
PN0030	Debakey Derra Clamp, Medium	171	48	Debakey 1 x 2
PN0031	Debakey Derra Clamp, Large	173	50	Debakey 1 x 2

COOLEY BULLDOG CLAMP, RING HANDLE



PN0342



1/1
PN0176

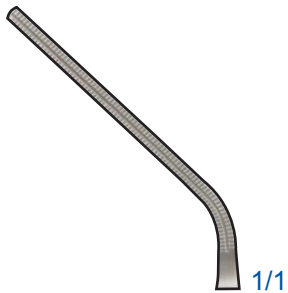

1/1
PN0341

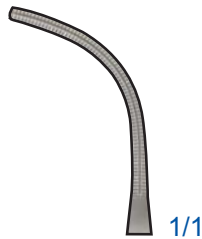

1/1
PN0178



1/1
PN0179

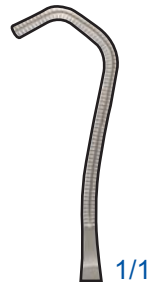

1/1
PN0342

CODE	DESCRIPTION	LENGTH	JAW LENGTH	TEETH
PN0176	Cooley Bulldog Clamp, Ring Handle, Straight	130	48	Cooley
PN0341	Cooley Bulldog Clamp, Ring Handle, Angled	127	46	Cooley
PN0178	Cooley Bulldog Clamp, Ring Handle, Curved	115	36	Cooley
PN0179	Cooley Bulldog Clamp, Ring Handle, Doubled Angled	127	46	Cooley
PN0342	Cooley Bulldog Clamp, Ring Handle, Satinsky Jaws	120	35	Cooley



PN0375

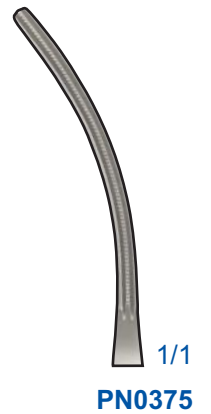
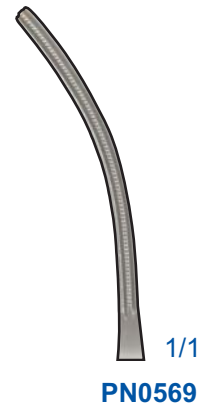
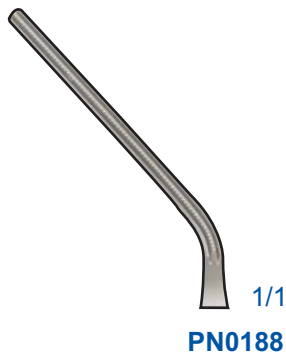

CODE	DESCRIPTION	LENGTH	JAW LENGTH	TEETH
PN0376	Debakey Bulldog Clamp, Ring Handle, Straight	135	50	Debakey 1 x 2
PN0188	Debakey Bulldog Clamp, Ring Handle, 45°	130	46	Debakey 1 x 2
PN0189	Debakey Bulldog Clamp, Ring Handle, 90°	105	38	Debakey 1 x 2
PN0569	Debakey Bulldog Clamp, Ring Handle, Curved Jaws	130	46	Debakey 1 x 2
PN0375	Debakey Bulldog Clamp, Ring Handle, Double Curved	130	47	Debakey 1 x 2

WOLFE MODIFIED COOLEY BULLDOG CLAMP



PN0143



1/1

CODE	DESCRIPTION	LENGTH	JAW LENGTH	TEETH
PN0143	Wolfe Modified Cooley Bulldog Clamp, Ring Handle, Double Angled	160	44	Cooley

COOLEY VESSEL CLAMP



PN0144



1/1

CODE	DESCRIPTION	LENGTH	JAW LENGTH	TEETH
PN0144	Cooley Vessel Clamp	165	50	Debakey 1 x 2



PN0370

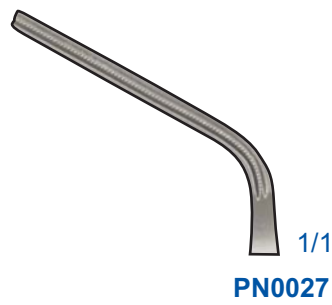
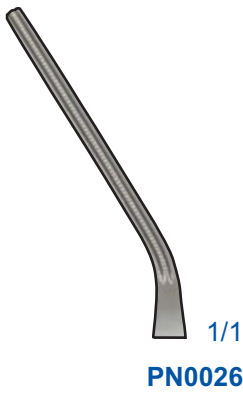

CODE	DESCRIPTION	LENGTH	JAW LENGTH	TEETH
PN0026	Debakey Miniature Clamp, 30°	165	47	Debakey 1 x 2
PN0027	Debakey Miniature Clamp, 60°	160	44	Debakey 1 x 2
PN0370	Debakey Miniature Clamp, 90°	146	41	Debakey 1 x 2

COOLEY MULTI PURPOSE CLAMP

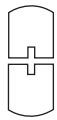

PN0035



1/1
PN0034

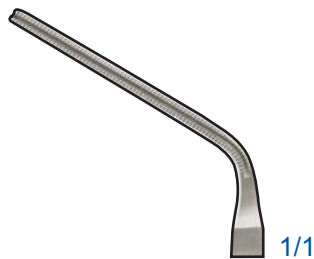

1/1
PN0035



1/1
PN0036

CODE	DESCRIPTION	LENGTH	JAW LENGTH	TEETH
PN0034	Cooley Multi Purpose Clamp, 30°	165	47	Cooley
PN0035	Cooley Multi Purpose Clamp, 60°	160	43	Cooley
PN0036	Cooley Multi Purpose Clamp, 90°	148	38	Cooley



PN0337

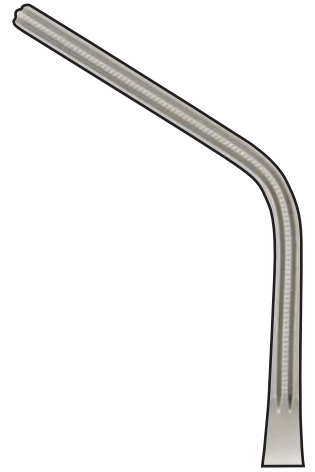

1/1



PN0371

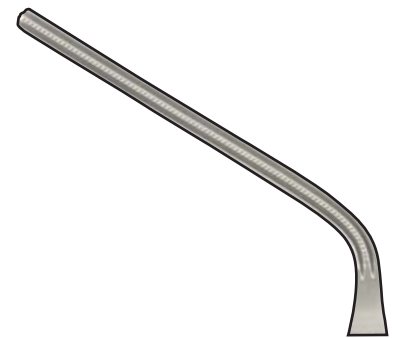

1/1

CODE	DESCRIPTION	LENGTH	JAW LENGTH	TEETH
PN0337	Debakey Multi Purpose Clamp No. 1, 60°	245	68	Debakey 1 x 2
PN0371	Debakey Multi Purpose Clamp No. 2, 60°	205	60	Debakey 1 x 2

DEBAKEY MULTI PURPOSE CLAMP



PN0154



1/1



PN0045

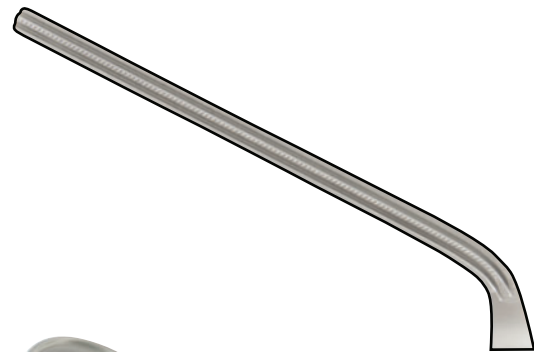

1/1

CODE	DESCRIPTION	LENGTH	JAW LENGTH	TEETH
PN0154	Debakey Multi Purpose Clamp No. 3, 60°	242	68	Debakey 1 x 2
PN0045	Debakey Multi Purpose Clamp No. 4, 60°	240	75	Debakey 1 x 2



PN0372

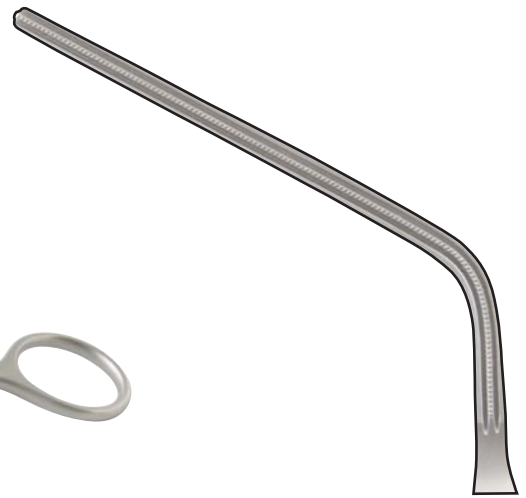

1/1



PN0373

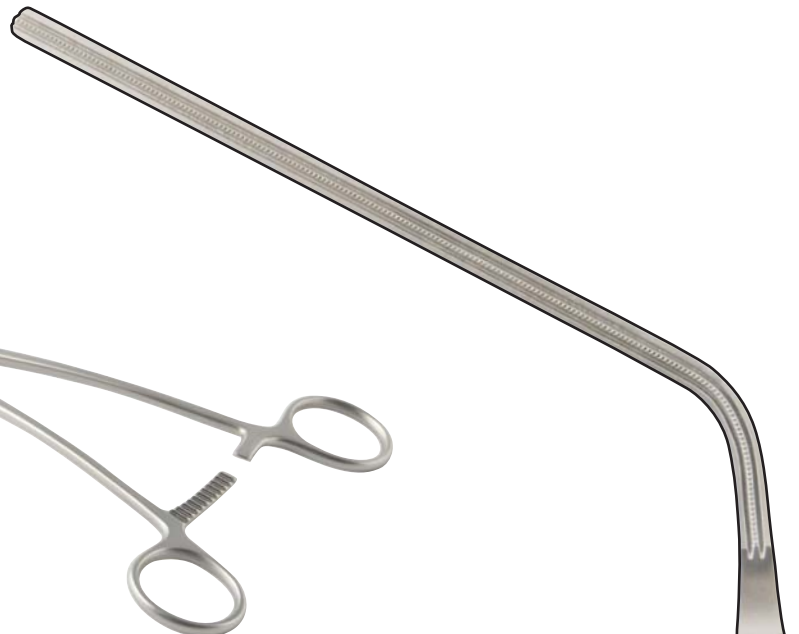

1/1

CODE	DESCRIPTION	LENGTH	JAW LENGTH	TEETH
PN0372	Debakey Multi Purpose Clamp No. 5, 60°	280	87	Debakey 1 x 2
PN0373	Debakey Multi Purpose Clamp No. 6, 60°	310	125	Debakey 1 x 2

DEBAKEY MULTI PURPOSE CLAMP



PN0540



1/1



PN0083



1/1

CODE	DESCRIPTION	LENGTH	JAW LENGTH	TEETH
PN0540	Debakey Multi Purpose Clamp No. 1, 90°	230	60	Debakey 1 x 2
PN0083	Debakey Multi Purpose Clamp No. 2, 90°	187	57	Debakey 1 x 2



PN0355



1/1



PN0356



1/1

CODE	DESCRIPTION	LENGTH	JAW LENGTH	TEETH
PN0355	Debakey Multi Purpose Clamp No. 3, 90°	220	70	Debakey 1 x 2
PN0356	Debakey Multi Purpose Clamp No. 4, 90°	270	110	Debakey 1 x 2

DARDIK MULTI PURPOSE CLAMP



PN0122



1/1

PN0351

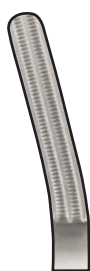

1/1

PN0349

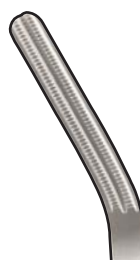

1/1

PN0122



1/1

PN0972



1/1

PN0124



1/1

PN0350

CODE	DESCRIPTION	LENGTH	JAW LENGTH	TEETH
PN0351	Dardik Multi Purpose Clamp, Small, Straight	150	35	Dardik
PN0349	Dardik Multi Purpose Clamp, Small, 15°	149	34	Dardik
PN0122	Dardik Multi Purpose Clamp, Small, 30°	148	33	Dardik
PN0972	Dardik Multi Purpose Clamp, Small, 45°	145	32	Dardik
PN0124	Dardik Multi Purpose Clamp, Small, 50°	142	31	Dardik
PN0350	Dardik Multi Purpose Clamp, Small, 90°	130	28	Dardik



PN0353

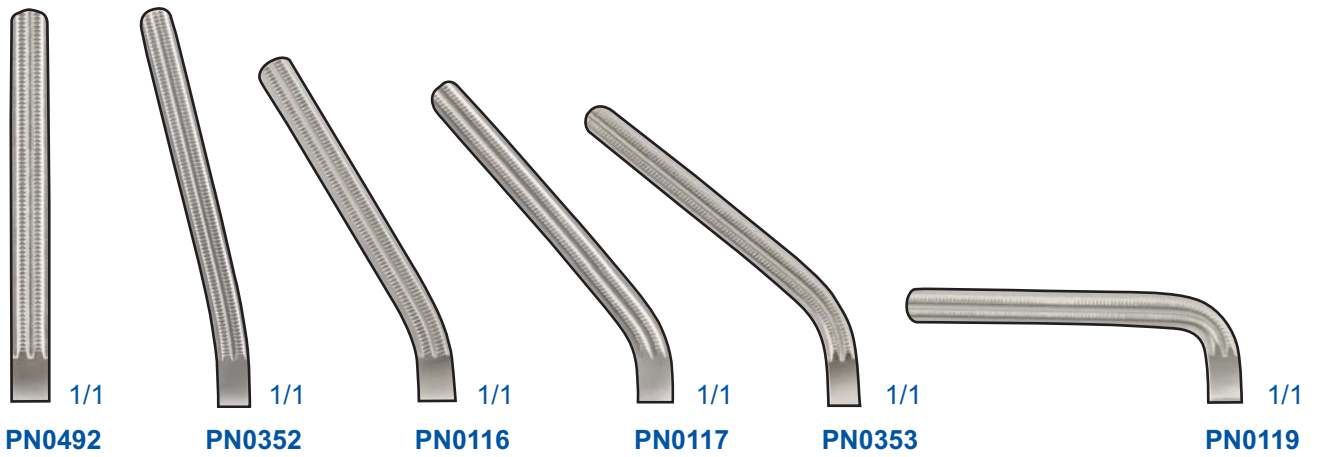

CODE	DESCRIPTION	LENGTH	JAW LENGTH	TEETH
PN0492	Dardik Multi Purpose Clamp, Large, Straight	170	55	Dardik
PN0352	Dardik Multi Purpose Clamp, Large, 15°	169	54	Dardik
PN0116	Dardik Multi Purpose Clamp, Large, 30°	165	53	Dardik
PN0117	Dardik Multi Purpose Clamp, Large, 45°	161	51	Dardik
PN0353	Dardik Multi Purpose Clamp, Large, 50°	158	50	Dardik
PN0119	Dardik Multi Purpose Clamp, Large, 90°	140	45	Dardik

CASTENADA CLAMP



PN1072

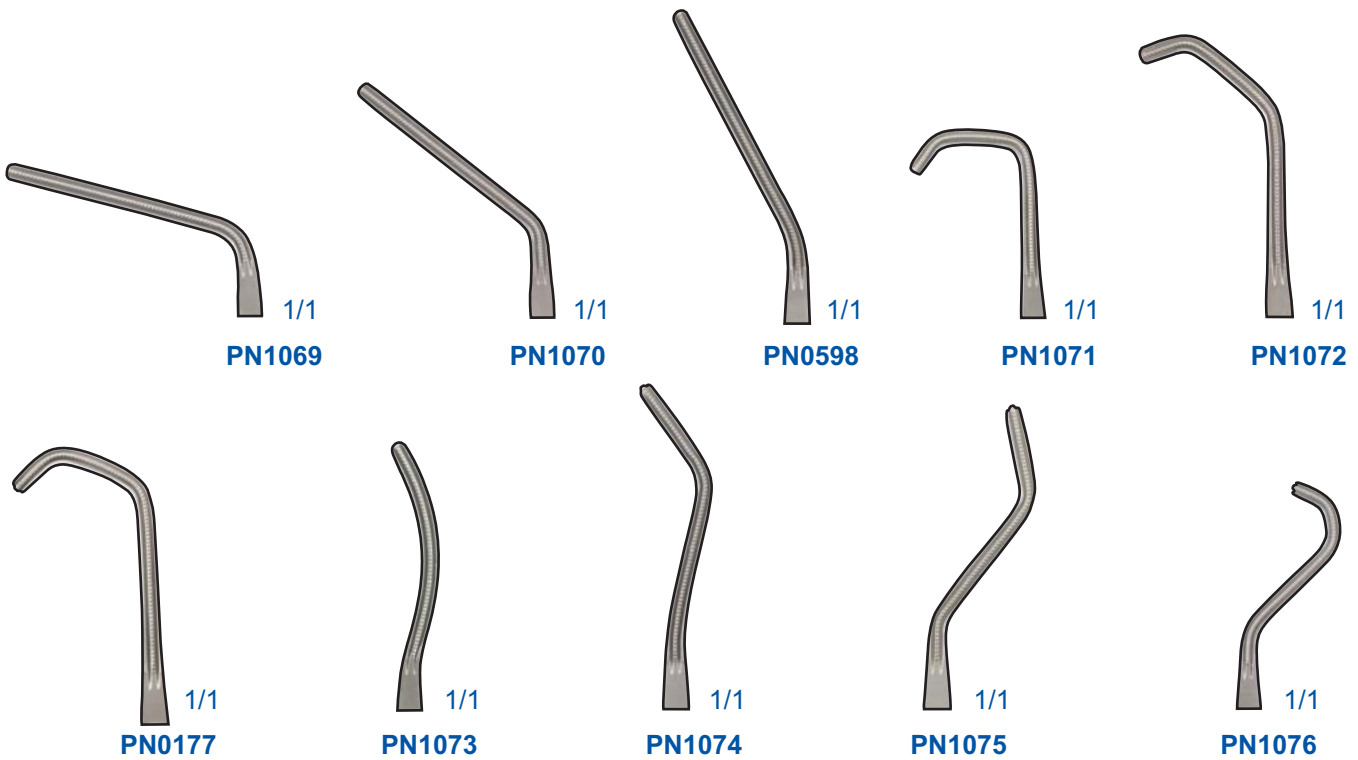

CODE	DESCRIPTION	LENGTH	JAW LENGTH	TEETH
PN1069	Castenada Clamp	110	35	Debakey 1 x 2
PN1070	Castenada Clamp	117	37	Debakey 1 x 2
PN0598	Castenada Clamp	126	42	Debakey 1 x 2
PN1071	Castenada Clamp	110	25	Debakey 1 x 2
PN1072	Castenada Clamp	120	37	Debakey 1 x 2
PN0177	Castenada Clamp	120	35	Debakey 1 x 2
PN1073	Castenada Clamp	120	35	Debakey 1 x 2
PN1074	Castenada Clamp	125	43	Debakey 1 x 2
PN1075	Castenada Clamp	120	40	Debakey 1 x 2
PN1076	Castenada Clamp	115	30	Debakey 1 x 2



PN0063



PN0059 1/1



PN0494 1/1

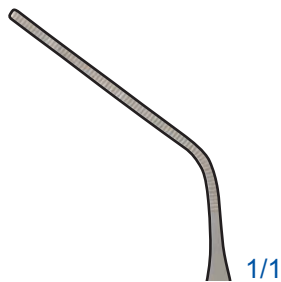

PN1077 1/1

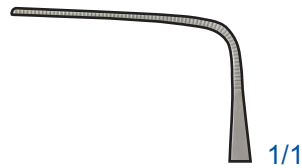

PN0062 1/1

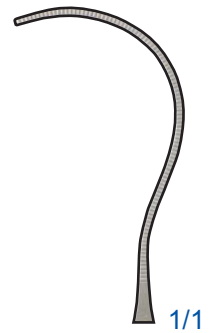

PN0063 1/1

CODE	DESCRIPTION	LENGTH	JAW LENGTH	TEETH
PN0059	Neonatal Miniature Clamp, Straight	128	47	Lateral
PN0494	Neonatal Miniature Clamp, 30°	127	46	Lateral
PN1077	Neonatal Miniature Clamp, 50°	125	43	Lateral
PN0062	Neonatal Miniature Clamp, 90°	112	36	Lateral
PN0063	Neonatal Miniature Clamp, Spoon	123	42	Lateral



PN0025

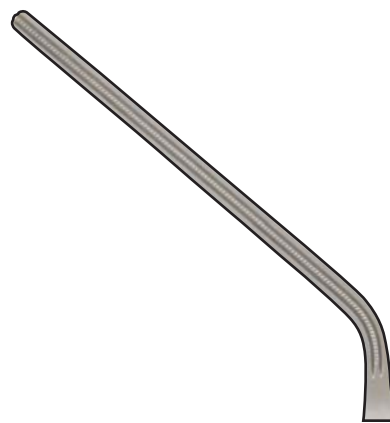

1/1



PN0033

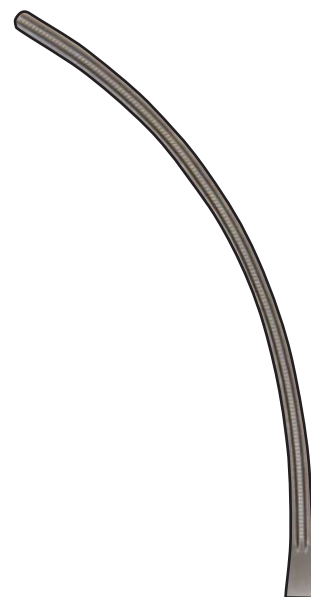

1/1



PN0382

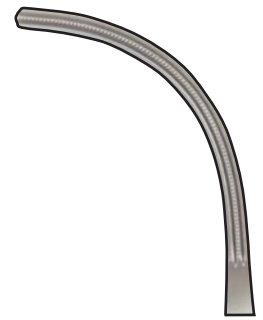

1/1

CODE	DESCRIPTION	LENGTH	JAW LENGTH	TEETH
PN0025	Debakey Peripheral Clamp, Angled	183	70	Debakey 1 x 2
PN0033	Debakey Peripheral Clamp, S Shape	200	83	Debakey 1 x 2
PN0382	Debakey Peripheral Vascular Clamp, Deep Curve	160	47	Debakey 1 x 2

LELAND JONES PERIPHERAL VASCULAR CLAMP



PN0555



1/1
PN0064

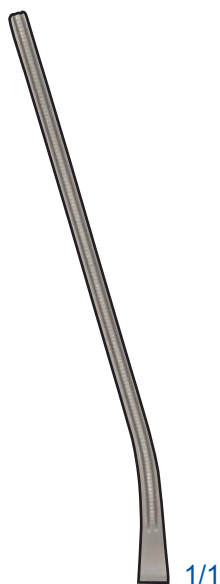

1/1
PN0128

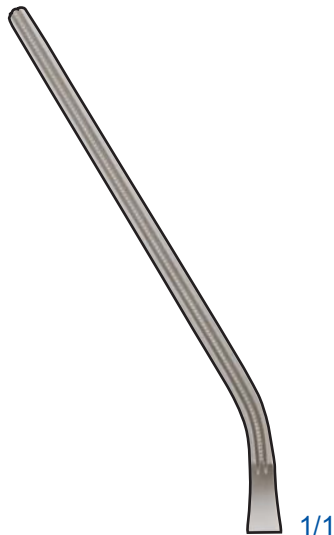

1/1
PN1096

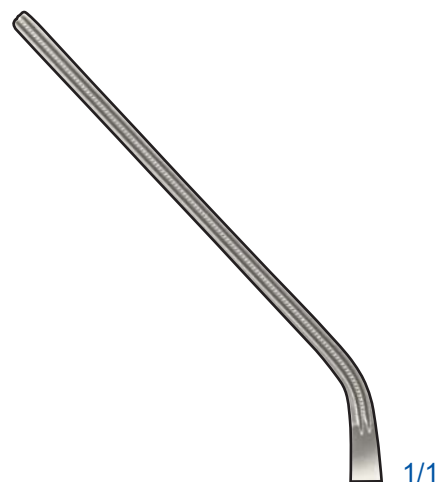

1/1
PN0555

CODE	DESCRIPTION	LENGTH	JAW LENGTH	TEETH
PN0064	Leland Jones Peripheral Vascular Clamp, Straight	195	79	Debakey 1 x 2
PN0128	Leland Jones Peripheral Vascular Clamp, 15°	195	77	Debakey 1 x 2
PN1096	Leland Jones Peripheral Vascular Clamp, 30°	190	75	Debakey 1 x 2
PN0555	Leland Jones Peripheral Vascular Clamp, 45°	186	75	Debakey 1 x 2



PN0587

1/1

CODE	DESCRIPTION	LENGTH	JAW LENGTH	TEETH
PN0587	Debakey Renal Clamp	198	80	Debakey 1 x 2

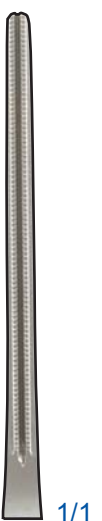

PN0294

1/1

CODE	DESCRIPTION	LENGTH	JAW LENGTH	TEETH
PN0294	Debakey Iliac Clamp	200	67	Debakey 1 x 2

DEBAKEY TANGENTIAL CLAMP



PN1080

CODE	DESCRIPTION	LENGTH	JAW LENGTH	TEETH
PN1078	Debakey Tangential Clamp No. 1	195	46	Debakey 1 x 2
PN1079	Debakey Tangential Clamp No. 2	255	55	Debakey 1 x 2
PN1080	Debakey Tangential Clamp No. 3	260	65	Debakey 1 x 2
PN1081	Debakey Tangential Clamp No. 4	270	75	Debakey 1 x 2
PN1082	Debakey Tangential Clamp No. 5	280	90	Debakey 1 x 2

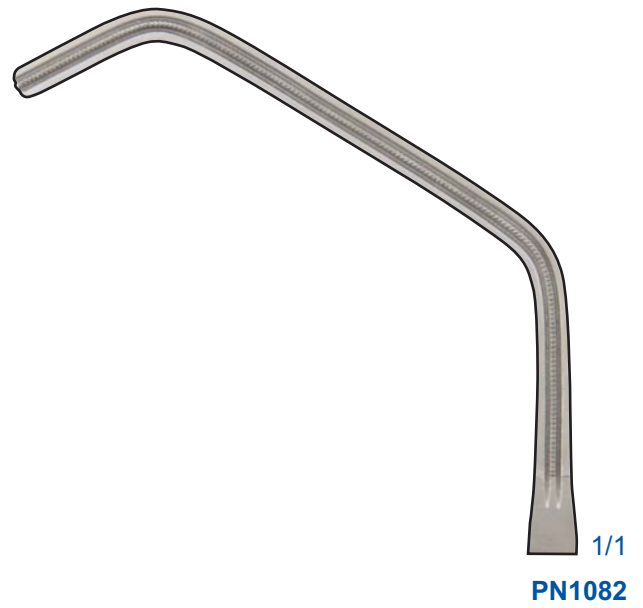



PN0101

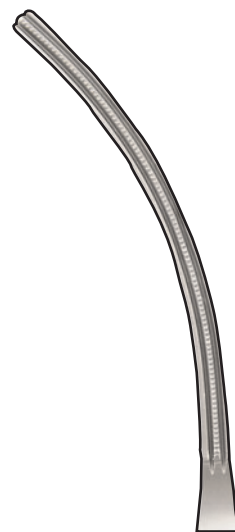

1/1



PN0384



1/1



PN0099

CODE	DESCRIPTION	LENGTH	JAW LENGTH	TEETH
PN0101	Debakey Aneurysm Clamp, Shallow Curve	260	70	Debakey 1 x 2
PN0384	Debakey Aneurysm Clamp, Medium Curve	255	68	Debakey 1 x 2
PN0099	Debakey Aneurysm Clamp, Deep Curve	245	59	Debakey 1 x 2

DEBAKEY AORTIC ANEURYSM CLAMP



PN0358



1/1



PN0102



1/1

CODE	DESCRIPTION	LENGTH	JAW LENGTH	TEETH
PN0358	Debakey Aortic Aneurysm Clamp	235	84	Debakey 1 x 2
PN0102	Debakey Aortic Aneurysm Clamp	270	93	Debakey 1 x 2



PN0107

1/1

CODE	DESCRIPTION	LENGTH	JAW LENGTH	TEETH
PN0107	Debakey Aortic Aneurysm Clamp	310	113	Debakey 1 x 2

DEBAKEY AORTIC ANEURYSM CLAMP



CODE	DESCRIPTION	LENGTH	JAW LENGTH	TEETH
PN0103	Debakey Aortic Aneurysm Clamp	310	113	Debakey 2 x 3



PN0024

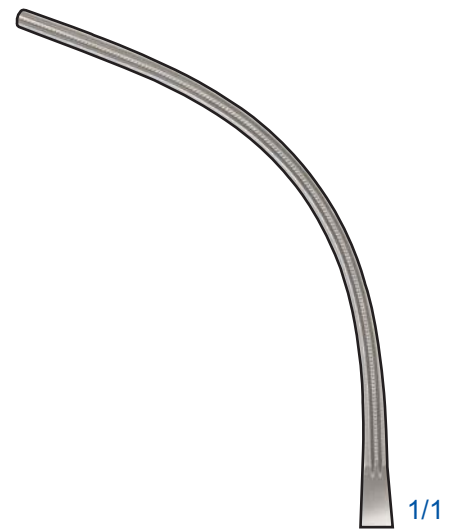

1/1

CODE	DESCRIPTION	LENGTH	JAW LENGTH	TEETH
PN0024	Debakey Aortic Occlusion Clamp	195	80	Debakey 1 x 2

MATTOX AORTA CLAMP



PN0180



1/1

CODE	DESCRIPTION	LENGTH	JAW LENGTH	TEETH
PN0180	Mattox Aorta Clamp	258	90	Debakey 1 x 2

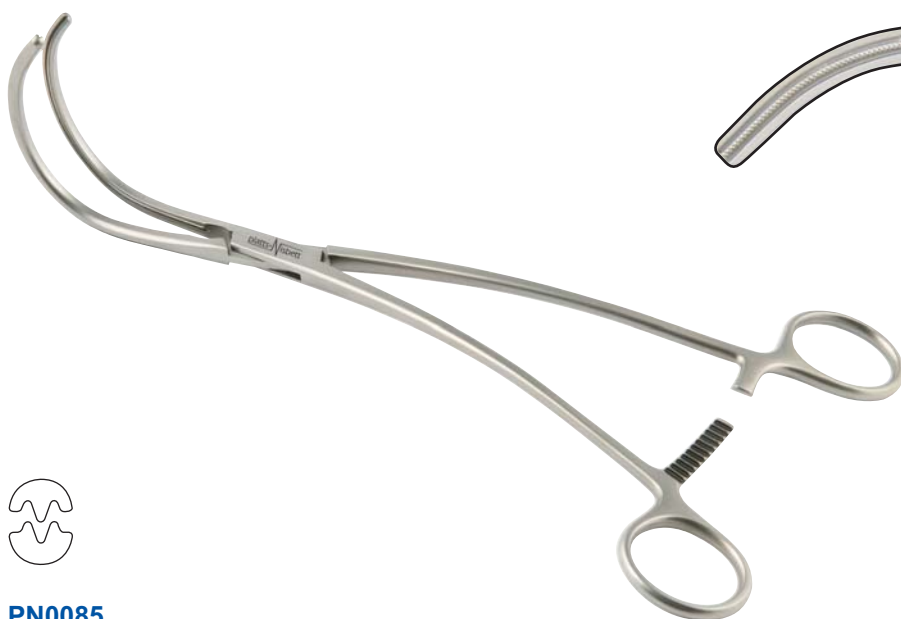

PN0085



PN0106



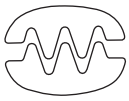

PN0105



1/1

CODE	DESCRIPTION	LENGTH	JAW LENGTH	TEETH
PN0085	Debakey Aortic Clamp, Full Curve	270	80	Debakey 1 x 2
PN0106	Debakey Aortic Clamp, Spoon	270	80	Debakey 2 x 3
PN0105	Debakey Aortic Clamp, S Shape	270	78	Debakey 2 x 3



MORRIS AORTA CLAMP

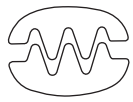

PN0301



1/1

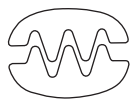

PN0407



1/1

CODE	DESCRIPTION	LENGTH	JAW LENGTH	TEETH
PN0301	Morris Aorta Clamp	210	85	Debakey 2 x 3
PN0407	Morris Aorta Clamp	282	87	Debakey 2 x 3



PN0164



1/1



PN0746



1/1

CODE	DESCRIPTION	LENGTH	JAW LENGTH	TEETH
PN0164	Lambert Kay Clamp	233	49	Debakey 1 x 2
PN0746	Lambert Kay Clamp	253	50	Debakey 1 x 2

BECK AORTIC CLAMP



PN0068



1/1

PN0068

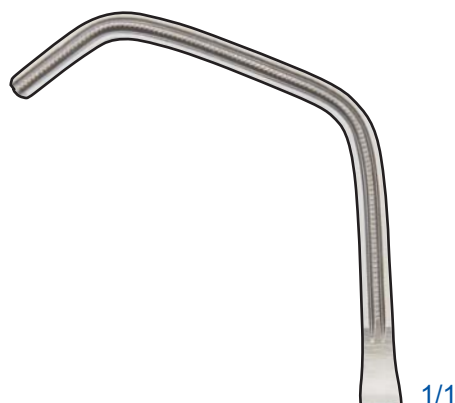

1/1

PN0710

CODE	DESCRIPTION	LENGTH	JAW LENGTH	TEETH
PN0068	Beck Aortic Clamp	195	42	Debakey 1 x 2
PN0710	Beck Aortic Clamp	205	60	Debakey 1 x 2



PN0140



1/1

CODE	DESCRIPTION	LENGTH	JAW LENGTH	TEETH
PN0140	Satinsky Clamp, Baby	165	47	Debakey 1 x 2

SATINSKY CLAMP



PN0071

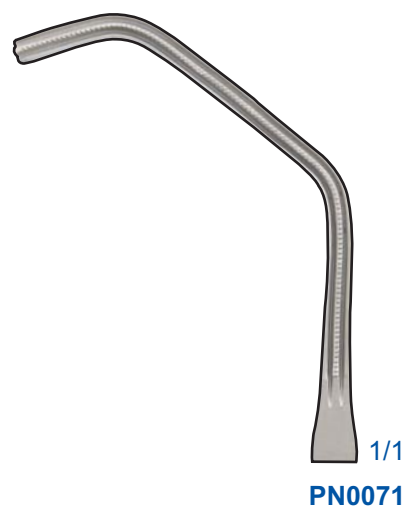
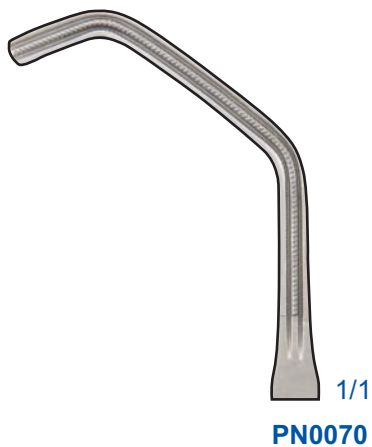
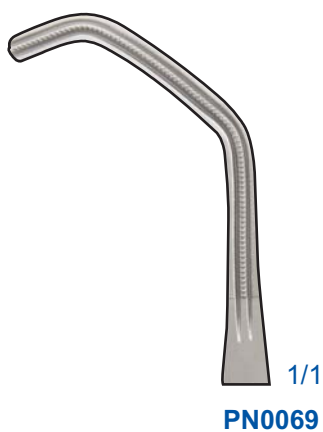

CODE	DESCRIPTION	LENGTH	JAW LENGTH	TEETH
PN0069	Satinsky Clamp, Small	235	50	Debakey 1 x 2
PN0070	Satinsky Clamp, Medium	240	55	Debakey 1 x 2
PN0071	Satinsky Clamp, Large	250	65	Debakey 1 x 2

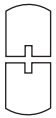

PN0166

CODE	DESCRIPTION	LENGTH	JAW LENGTH	TEETH
PN0166	Ross Vena Cava Clamp, 26 Charriere	215	72	Cooley
PN0647	Ross Vena Cava Clamp, 28 Charriere	215	72	Cooley
PN0584	Ross Vena Cava Clamp, 32 Charriere	215	72	Cooley

JAVID CAROTID ARTERY CLAMP



PN0532



PN0291

CODE	DESCRIPTION	LENGTH	JAW LENGTH
PN0532	Javid Carotid Artery Clamp, Small	170	55
PN0291	Javid Carotid Artery Clamp, Large	185	75



PN1088



1/1



PN1090

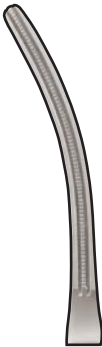

1/1

CODE	DESCRIPTION	LENGTH	JAW LENGTH	TEETH
PN1088	Debakey Bainbridge Clamp, Straight	165	46	Debakey 1 x 2
PN1090	Debakey Bainbridge Clamp, Curved	165	45	Debakey 1 x 2

DEBAKEY BAINBRIDGE CLAMP



PN1089



1/1



PN0359



1/1

CODE	DESCRIPTION	LENGTH	JAW LENGTH	TEETH
PN1089	Debakey Bainbridge Clamp, Straight	185	65	Debakey 1 x 2
PN0359	Debakey Bainbridge Clamp, Curved	185	68	Debakey 1 x 2



PN0361



1/1



PN0360



1/1

CODE	DESCRIPTION	LENGTH	JAW LENGTH	TEETH
PN0361	Debakey Coarctation Clamp, Straight	170	55	Debakey 1 x 2
PN0360	Debakey Coarctation Clamp, Angled Shank	170	55	Debakey 1 x 2

DEBAKEY COARCTATION CLAMP



PN0077



1/1



PN0078



1/1

CODE	DESCRIPTION	LENGTH	JAW LENGTH	TEETH
PN0077	Debakey Coarctation Clamp, Straight	220	67	Debakey 1 x 2
PN0078	Debakey Coarctation Clamp, Angled Shank	215	67	Debakey 1 x 2



PN0507



1/1



PN0163



1/1

CODE	DESCRIPTION	LENGTH	JAW LENGTH	TEETH
PN0507	Debakey Coarctation Clamp, Straight	257	80	Debakey 1 x 2
PN0163	Debakey Coarctation Clamp, Angled Shank	255	80	Debakey 1 x 2

DEBAKEY COARCTATION CLAMP



PN0052



1/1

CODE	DESCRIPTION	LENGTH	JAW LENGTH	TEETH
PN0052	Debakey Coarctation Clamp, Curved	165	50	Debakey 1 x 2



PN0705



PN0571 1/1



PN0039 1/1

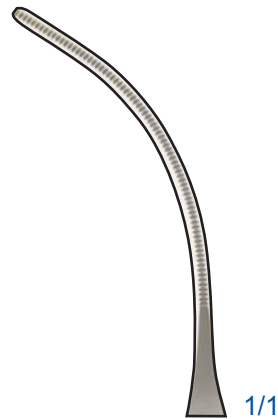

PN0097 1/1



PN0705 1/1

CODE	DESCRIPTION	LENGTH	JAW LENGTH	TEETH
PN0571	Potts Coarctation Clamp, Straight	209	59	Lateral
PN0039	Potts Coarctation Clamp, Angled Shank	205	58	Lateral
PN0097	Potts Coarctation Clamp, Curved	205	58	Lateral
PN0705	Potts Coarctation Clamp, Spoon	203	62	Lateral

CRAFOORD COARCTATION CLAMP



PN0347



1/1

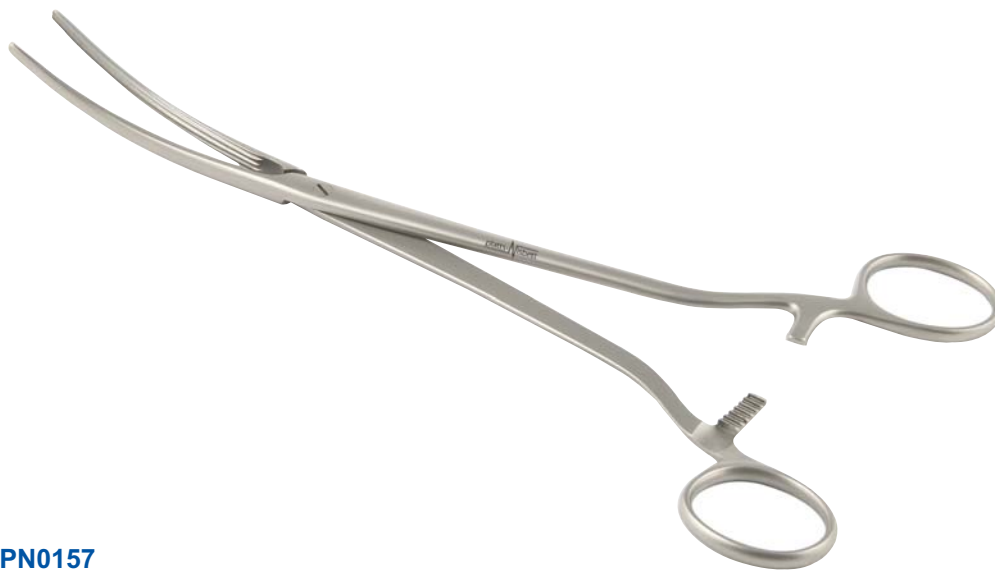

PN0157

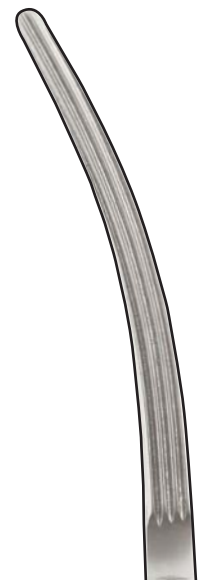

1/1

CODE	DESCRIPTION	LENGTH	JAW LENGTH	TEETH
PN0347	Crafoord Coarctation Clamp, Straight	255	78	Longitudinal
PN0157	Crafoord Coarctation Clamp, Slight Curve	253	75	Longitudinal



PN0348

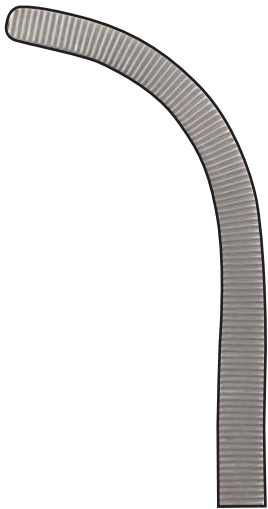

1/1



PN0295

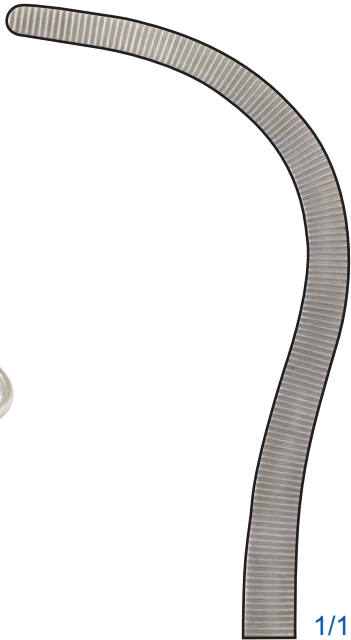

1/1

CODE	DESCRIPTION	LENGTH	JAW LENGTH	TEETH
PN0348	Crafoord Dissecting Clamp, Medium Curve	245	68	Lateral
PN0295	Crafoord Dissecting Clamp, Full Curve	260	85	Lateral

GLOVER CLAMP



PN0079

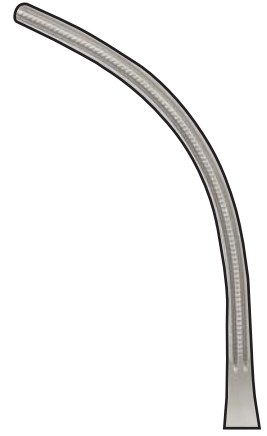

1/1



PN0393



1/1

CODE	DESCRIPTION	LENGTH	JAW LENGTH	TEETH
PN0079	Glover Clamp, Curved	210	60	Debakey 1 x 2
PN0393	Glover Clamp, Spoon	215	60	Debakey 1 x 2



PN0096

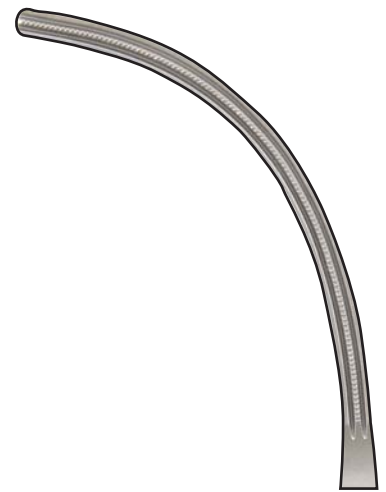

1/1



PN0394



1/1

CODE	DESCRIPTION	LENGTH	JAW LENGTH	TEETH
PN0096	Glover Clamp, Curved	250	73	DeBakey 1 x 2
PN0394	Glover Clamp, Spoon	257	77	DeBakey 1 x 2

BROCK AURICULAR CLAMP



PN0088

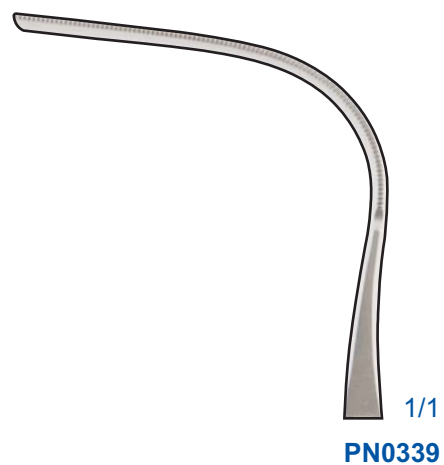
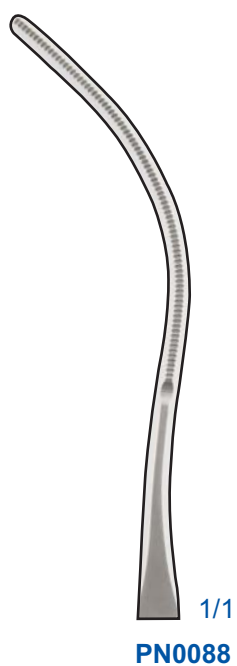
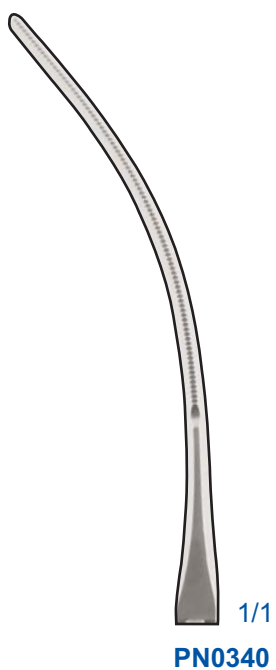

CODE	DESCRIPTION	LENGTH	JAW LENGTH	TEETH
PN0340	Brock Auricular Clamp, Shallow Curve	232	82	Brock
PN0088	Brock Auricular Clamp, Medium Curve	230	80	Brock
PN0339	Brock Auricular Clamp, Deep Curve	213	70	Brock



PN0402

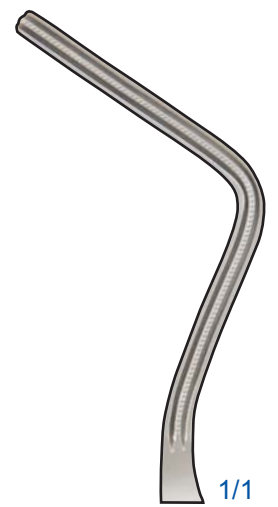

PN0401



CODE	DESCRIPTION	LENGTH	JAW LENGTH	TEETH
PN0402	Lees Bronchus Clamp, Slight Angled Jaw	245	65	Debakey 1 x 2
PN0401	Lees Bronchus Clamp, 90°	223	57	Debakey 1 x 2

PRICE THOMAS BRONCHUS CLAMP



PN0273



PN0274 1/1



PN0273 1/1



PN0243 1/1

CODE	DESCRIPTION	LENGTH	JAW LENGTH	TEETH
PN0274	Price Thomas Bronchus Clamp, Plain	220	50	Longitudinal
PN0273	Price Thomas Bronchus Clamp, Teeth on Left	220	50	Longitudinal
PN0243	Price Thomas Bronchus Clamp, Teeth on Right	220	50	Longitudinal



PN0086

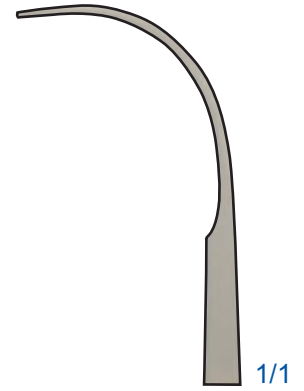

1/1



PN0293

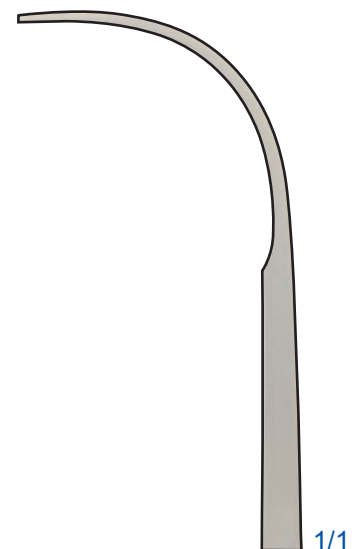

1/1

CODE	DESCRIPTION	LENGTH	JAW LENGTH
PN0086	Semb Ligature Passing Forceps, Child, Full Curve	210	55
PN0293	Semb Ligature Passing Forceps, Adult, Full Curve	245	77

SEMB LIGATURE PASSING FORCEPS



PN0418



1/1

CODE	DESCRIPTION	LENGTH	JAW LENGTH
PN0418	Semb Ligature Passing Forceps, Adult, Slight Curve	245	73



PN0417

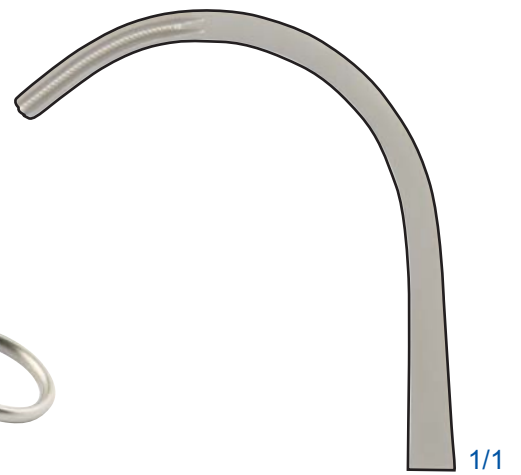

PN0046



CODE	DESCRIPTION	LENGTH	JAW LENGTH	TEETH
PN0417	Debakey Modified Semb Ligature Passing Forceps, Full Curve, Serrated Tips	264	68	Debakey 1 x 2
PN0046	Debakey Ligature Forceps, Full Curve	170	50	Debakey 1 x 2



PN0426



1/1



PN0425



1/1



PN0424



1/1

CODE	DESCRIPTION	LENGTH	JAW LENGTH	TEETH
PN0426	Ulrich Clamp, Small	260	64	Lateral
PN0425	Ulrich Clamp, Medium	270	75	Lateral
PN0424	Ulrich Clamp, Large	280	87	Lateral

SWINNEY CLAMP



PN0420

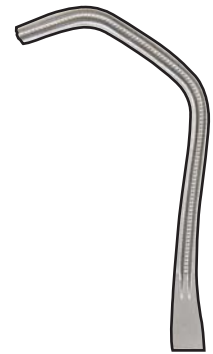

1/1



PN0419

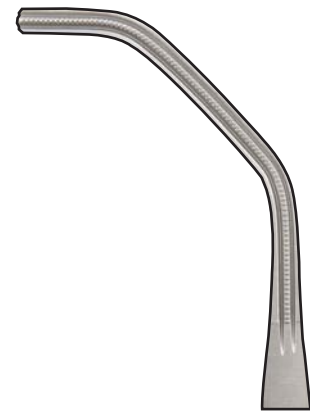

1/1

CODE	DESCRIPTION	LENGTH	JAW LENGTH	TEETH
PN0420	Swinney Clamp, Child	150	45	Debakey 1 x 2
PN0419	Swinney Clamp, Adult	235	60	Debakey 1 x 2



PN0267

1/1

CODE	DESCRIPTION	LENGTH	JAW LENGTH	TEETH
PN0267	Tubing Clamp, Heavy Pattern	200	48	Lateral

TUBING CLAMP



PN0160

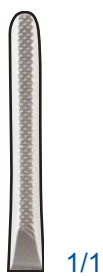

1/1

PN0159

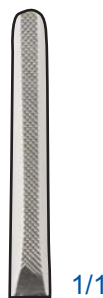

1/1

PN0160

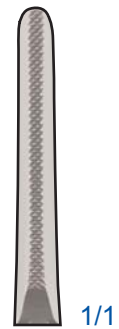

1/1

PN0161

CODE	DESCRIPTION	LENGTH	JAW LENGTH
PN0159	Tubing Clamp, Wedge Jaw	150	34
PN0160	Tubing Clamp, Wedge Jaw	182	38
PN0161	Tubing Clamp, Wedge Jaw	207	42



PN0422

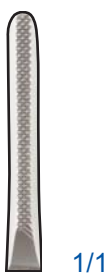

1/1

PN0421



1/1

PN0422



1/1

PN0423

CODE	DESCRIPTION	LENGTH	JAW LENGTH
PN0421	Tubing Clamp, Wedge Jaw, With Safety Guard	150	34
PN0422	Tubing Clamp, Wedge Jaw, With Safety Guard	182	38
PN0423	Tubing Clamp, Wedge Jaw, With Safety Guard	207	42



LAHEY ARTERY FORCEPS



PN0436

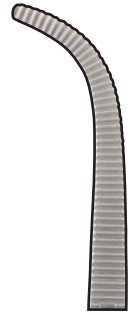

1/1

CODE	DESCRIPTION	LENGTH	JAW LENGTH	TEETH
PN0436	Lahey Artery Forceps	200	40	Lateral



PN0175

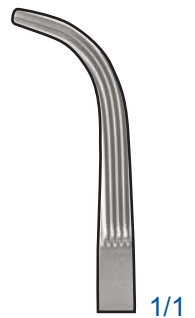

PN0174



CODE	DESCRIPTION	LENGTH	JAW LENGTH	TEETH
PN0175	Lahey Artery Forceps	200	40	Longitudinal
PN0174	Lahey Artery Forceps	235	54	Longitudinal

LLOYD DAVIS ARTERY FORCEPS



PN0322

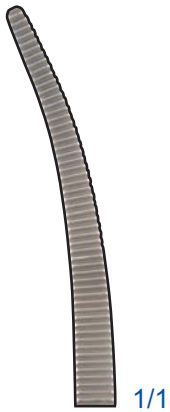

PN0403

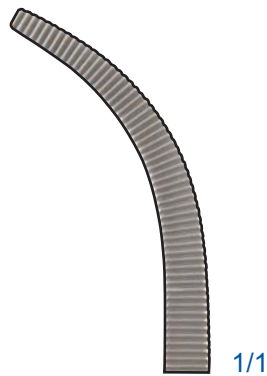

PN0322

CODE	DESCRIPTION	LENGTH	JAW LENGTH	TEETH
PN0403	Lloyd Davis Artery Forceps, Slight Curve	257	53	Lateral
PN0322	Lloyd Davis Artery Forceps, Deep Curve	255	50	Lateral



1/1

PN0973

CODE	DESCRIPTION	LENGTH	JAW LENGTH	TEETH
PN0973	Nelson Roberts Forceps	235	55	Lateral

SAWTELL FORCEPS



1/1

PN0965

CODE	DESCRIPTION	LENGTH	JAW LENGTH	TEETH
PN0965	Sawtell Forceps	230	40	Lateral

ROBERTS ARTERY FORCEPS



1/1

PN0191

CODE	DESCRIPTION	LENGTH	JAW LENGTH	TEETH
PN0191	Roberts Artery Forceps	300	55	Lateral

MOYNIHAN CLAMP



1/1

PN0152

CODE	DESCRIPTION	LENGTH	JAW LENGTH	TEETH
PN0152	Moynihan Clamp, Curved	225	40	Lateral



PN0098

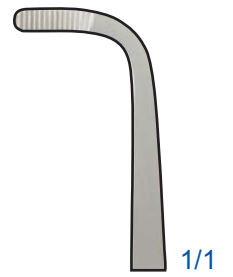

1/1



PN0100



1/1

CODE	DESCRIPTION	LENGTH	JAW LENGTH	TEETH
PN0098	Waterston Dissecting Forceps, Angled	155	35	Lateral
PN0100	Waterston Dissecting Forceps, Curved	167	41	Lateral

WATERSTON DISSECTING FORCEPS



PN0711

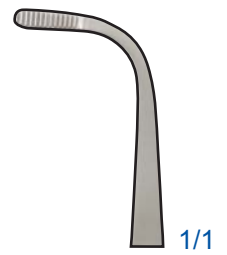

PN0696



CODE	DESCRIPTION	LENGTH	JAW LENGTH	TEETH
PN0711	Waterston Dissecting Forceps, Angled, Delicate Model	155	33	Lateral
PN0696	Waterston Dissecting Forceps, Curved, Delicate Model	155	40	Lateral



PN0706



PN0694

CODE	DESCRIPTION	LENGTH	JAW LENGTH	TEETH
PN0706	Waterston Dissecting Forceps, Angled, Delicate Model	170	43	Lateral
PN0694	Waterston Dissecting Forceps, Curved, Delicate Model	170	41	Lateral

WATERSTON DISSECTING FORCEPS



PN0949

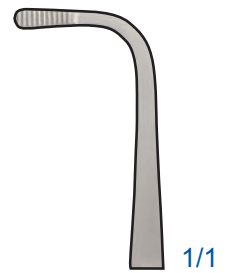

PN0948

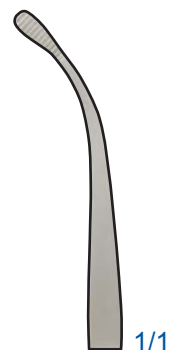

CODE	DESCRIPTION	LENGTH	JAW LENGTH	TEETH
PN0949	Waterston Dissecting Forceps, Angled, with Bulbous Tip	155	35	Lateral
PN0948	Waterston Dissecting Forceps, Curved, with Bulbous Tip	165	45	Lateral



PN0585

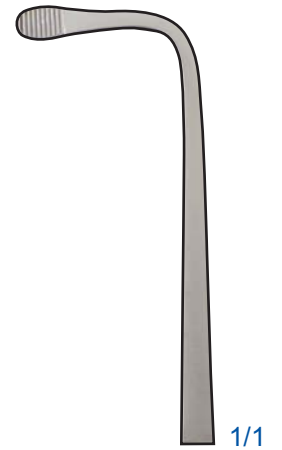

PN0578

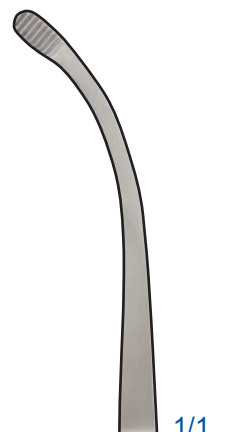

CODE	DESCRIPTION	LENGTH	JAW LENGTH	TEETH
PN0585	Waterston Dissecting Forceps, Angled	203	58	Lateral
PN0578	Waterston Dissecting Forceps, Curved	203	58	Lateral

WATERSTON VESSEL CLAMP

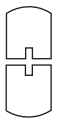

PN0583

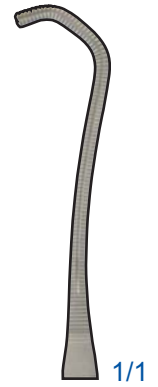

PN0302

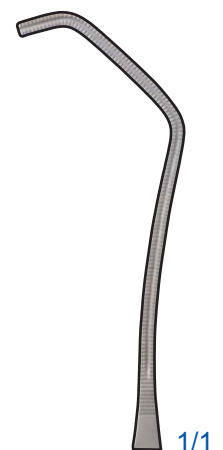

CODE	DESCRIPTION	LENGTH	JAW LENGTH	TEETH
PN0583	Waterston Vessel Clamp, Delicate Model	165	47	Cooley
PN0302	Waterston Vessel Clamp, Delicate Model	180	57	Cooley



PN0104

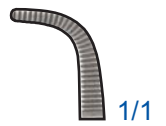

1/1

CODE	DESCRIPTION	LENGTH	JAW LENGTH	TEETH
PN0104	Lincoln Dissecting Forceps	115	15	Lateral

COLLINGWOOD STEWART HERNIA FORCEPS



PN0095

CODE	DESCRIPTION	LENGTH
PN0095	Collingwood Stewart Hernia Forceps	125

KING VEIN GRAFT PRESS FORCEPS



PN0541

CODE	DESCRIPTION	LENGTH	JAW LENGTH	TEETH
PN0541	King Vein Graft Press Forceps	145	20	Circular

PURSE STRING FORCEPS



PN0087

CODE	DESCRIPTION	LENGTH
PN0087	Purse String Forceps	240

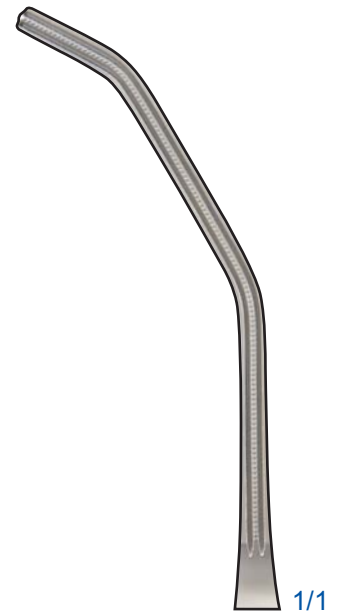

PN0335

CODE	DESCRIPTION	LENGTH	JAW LENGTH	TEETH
PN0335	Herrick Kidney Pedicle Clamp	260	82	Debakey 1 x 2

FISTULA CLAMP



PN0383

CODE	DESCRIPTION	LENGTH	JAW LENGTH	TEETH
PN0383	Fistula Clamp	117	35	Debakey 1 x 2

DOYEN CLAMP



PN0628



1/1



PN0306

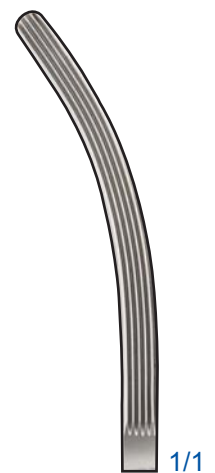

1/1

CODE	DESCRIPTION	LENGTH	JAW LENGTH	TEETH
PN0628	Doyen Clamp, Baby, Straight	177	64	Longitudinal
PN0306	Doyen Clamp, Baby, Curved	175	60	Longitudinal



PN0627

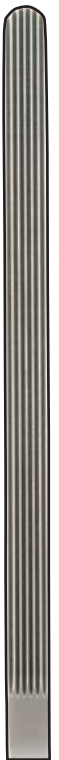

1/1



PN0679

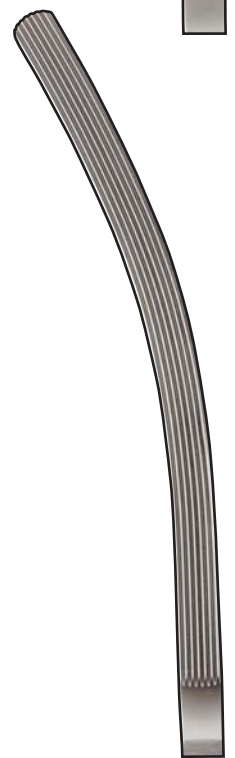

1/1

CODE	DESCRIPTION	LENGTH	JAW LENGTH	TEETH
PN0627	Doyen Clamp, Adult, Straight	230	100	Longitudinal
PN0679	Doyen Clamp, Adult, Curved	230	98	Longitudinal

DOYEN CLAMP

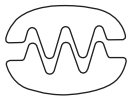

PN0387



1/1

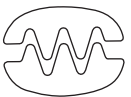

PN0129

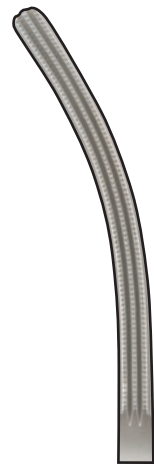

1/1

CODE	DESCRIPTION	LENGTH	JAW LENGTH	TEETH
PN0387	Doyen Clamp, Baby, Straight	177	62	Debakey 2 x 3
PN0129	Doyen Clamp, Baby, Curved	175	60	Debakey 2 x 3

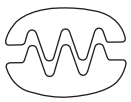

PN0388



1/1

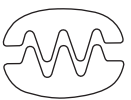

PN0130

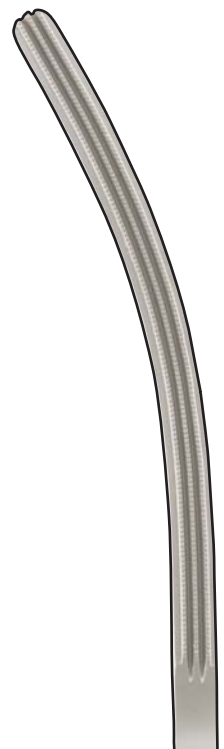

1/1

CODE	DESCRIPTION	LENGTH	JAW LENGTH	TEETH
PN0388	Doyen Clamp, Adult, Straight	230	102	Debakey 2 x 3
PN0130	Doyen Clamp, Adult, Curved	228	98	Debakey 2 x 3

PARKER KERR CLAMP



PN0552

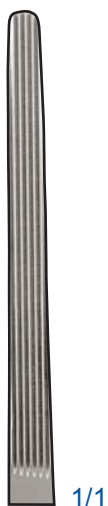

PN0552

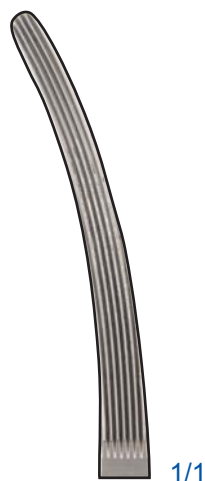

PN0300

CODE	DESCRIPTION	LENGTH	JAW LENGTH	TEETH
PN0552	Parker Kerr Clamp, Small, Straight	242	65	Longitudinal
PN0300	Parker Kerr Clamp, Small, Curved	238	61	Longitudinal



PN0270

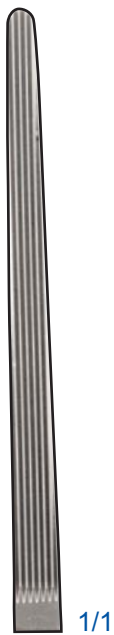

PN0299

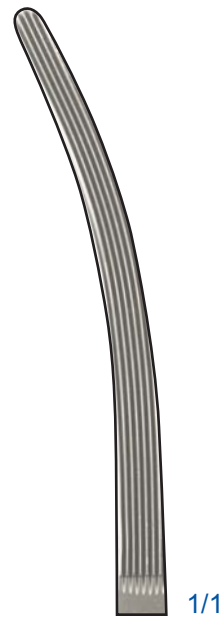

PN0270

CODE	DESCRIPTION	LENGTH	JAW LENGTH	TEETH
PN0299	Parker Kerr Clamp, Large, Straight	258	83	Longitudinal
PN0270	Parker Kerr Clamp, Large, Curved	255	80	Longitudinal

PAYR INTESTINAL CLAMP



PN0213



PN0414

CODE	DESCRIPTION	LENGTH	JAW LENGTH	TEETH
PN0213	Payr Intestinal Clamp	202	58	Longitudinal
PN0414	Payr Intestinal Clamp	250	106	Longitudinal



PN0123



1/1

CODE	DESCRIPTION	LENGTH	JAW LENGTH	TEETH
PN0123	Tanner (Lane) Twin Clamp, Straight	313	165	Longitudinal

LANE TWIN CLAMP



PN0400



1/1

CODE	DESCRIPTION	LENGTH	JAW LENGTH	TEETH
PN0400	Lane Twin Clamp, Straight	307	157	Longitudinal



PN0399

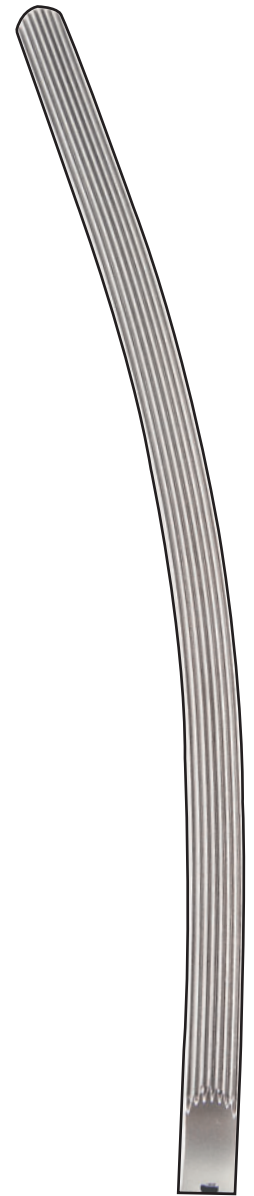

1/1

CODE	DESCRIPTION	LENGTH	JAW LENGTH	TEETH
PN0399	Lane Twin Clamp, Curved	305	155	Longitudinal

GEARY GRANT FORCEPS



PN1095



CODE	DESCRIPTION	LENGTH	JAW LENGTH	TEETH
PN1095	Geary Grant Forceps, Small	220	43	Longitudinal



PN0307

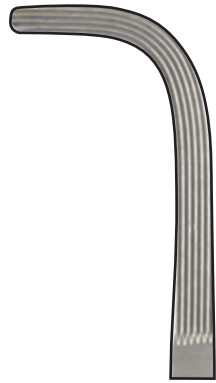

1/1

CODE	DESCRIPTION	LENGTH	JAW LENGTH	TEETH
PN0307	Geary Grant Forceps, Large	225	50	Longitudinal

DEBAKEY HYSTERECTOMY CLAMP

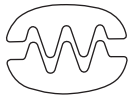

PN0142



1/1



PN0365

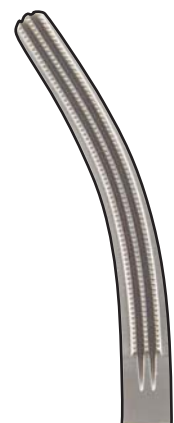

1/1

CODE	DESCRIPTION	LENGTH	JAW LENGTH	TEETH
PN0142	Debakey Hysterectomy Clamp, Straight	220	54	Debakey 2 x 3
PN0365	Debakey Hysterectomy Clamp, Slight Curved Jaws	220	54	Debakey 2 x 3

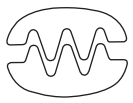

PN0366

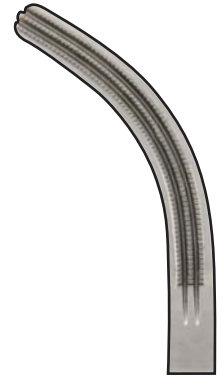

1/1



PN0364

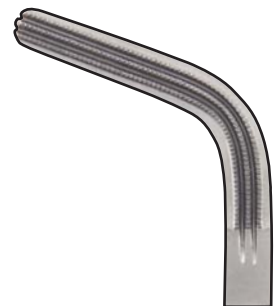

1/1

CODE	DESCRIPTION	LENGTH	JAW LENGTH	TEETH
PN0366	Debakey Hysterectomy Clamp, Deep Curved Jaws	215	49	Debakey 2 x 3
PN0364	Debakey Hysterectomy Clamp, Angled Jaws	205	44	Debakey 2 x 3

DEBAKEY HYSTERECTOMY CLAMP

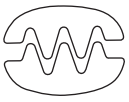

PN0146



1/1

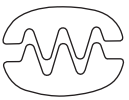

PN0368

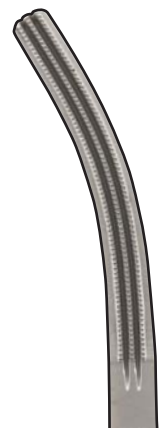

1/1

CODE	DESCRIPTION	LENGTH	JAW LENGTH	TEETH
PN0146	Debakey Hysterectomy Clamp, Straight	243	55	Debakey 2 x 3
PN0368	Debakey Hysterectomy Clamp, Slight Curved Jaws	243	54	Debakey 2 x 3

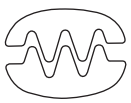

PN0369



1/1

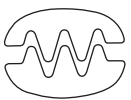

PN0367



1/1

CODE	DESCRIPTION	LENGTH	JAW LENGTH	TEETH
PN0369	Debakey Hysterectomy Clamp, Deep Curved Jaws	240	50	Debakey 2 x 3
PN0367	Debakey Hysterectomy Clamp, Angled Jaws	225	43	Debakey 2 x 3

MAINGOT HYSTERECTOMY FORCEPS



PN0405

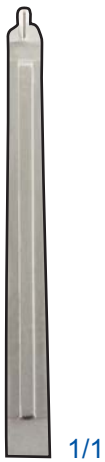

PN0405

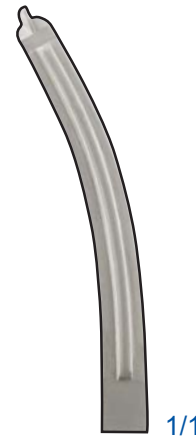

PN0153

CODE	DESCRIPTION	LENGTH	JAW LENGTH
PN0405	Maingot Hysterectomy Forceps, Small, Straight, Tenaculum Point	210	59
PN0153	Maingot Hysterectomy Forceps, Small, Curved, Tenaculum Point	205	57



PN0406



1/1

PN0319



1/1

PN0406

CODE	DESCRIPTION	LENGTH	JAW LENGTH
PN0319	Maingot Hysterectomy Forceps, Large, Straight, Tenaculum Point	251	61
PN0406	Maingot Hysterectomy Forceps, Large, Curved, Tenaculum Point	248	59

GWILLIAMS HYSTERECTOMY CLAMP



PN0139



1/1

PN0395



1/1

PN0139

CODE	DESCRIPTION	LENGTH	JAW LENGTH	TEETH
PN0395	Gwilliams Hysterectomy Clamp, Straight, 1 x 2 Tenaculum Point	208	57	Longitudinal
PN0139	Gwilliams Hysterectomy Clamp, Curved, 1 x 2 Tenaculum Point	205	55	Longitudinal

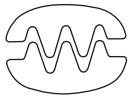

PN0032

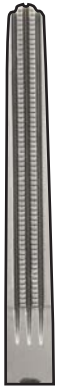

1/1



PN0138

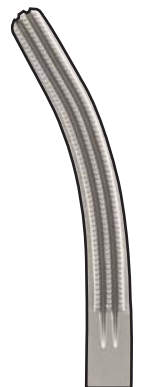

1/1

CODE	DESCRIPTION	LENGTH	JAW LENGTH	TEETH
PN0032	Rogers Hysterectomy Clamp, Straight	215	50	Debakey 2 x 3
PN0138	Rogers Hysterectomy Clamp, Curved	214	49	Debakey 2 x 3

READ STALLWORTHY HYSTERECTOMY CLAMP



PN0141

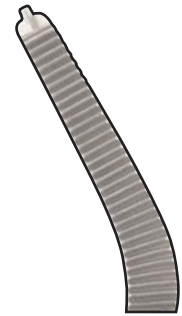

1/1



PN0084

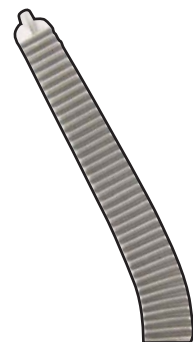

1/1

CODE	DESCRIPTION	LENGTH	JAW LENGTH	TEETH
PN0141	Read Stallworthy Hysterectomy Clamp (Chelsea Pattern), Tenaculum Point	205	42	Lateral
PN0084	Read Stallworthy Hysterectomy Clamp, Tenaculum Point	224	47	Lateral



PN0564



1/1

CODE	DESCRIPTION	LENGTH	JAW LENGTH	TEETH
PN0564	Howkin Hysterectomy Clamp, 1 x 2 Tenaculum Point	212	46	Longitudinal

TEALE VULSELLUM FORCEPS



PN0357

CODE	DESCRIPTION	LENGTH	JAW LENGTH	TEETH
PN0357	Teale Vulsellum Forceps	225	55	3 x 4

FINCH EXCISION CLAMP



PN0390

CODE	DESCRIPTION	LENGTH	JAW LENGTH	TEETH
PN0390	Finch Excision Clamp	235	95	Hollow

LLOYD DAVIS RECTAL OCCLUSION FORCEPS



PN0061

CODE	DESCRIPTION	LENGTH	JAW LENGTH	TEETH
PN0061	Lloyd Davis Rectal Occlusion Forceps	330	95	Longitudinal



1/1

PN0396

CODE	DESCRIPTION	LENGTH	JAW LENGTH	TEETH
PN0396	Houghton Excision Clamp	255	85	Longitudinal

EINSELL FOSS COLON CLAMP



1/1

PN0389

CODE	DESCRIPTION	LENGTH	JAW LENGTH	TEETH
PN0389	Einsell Foss Colon Clamp	310	90	Debakey 1 x 2



HAYES COLON RESECTION CLAMP



PN0108

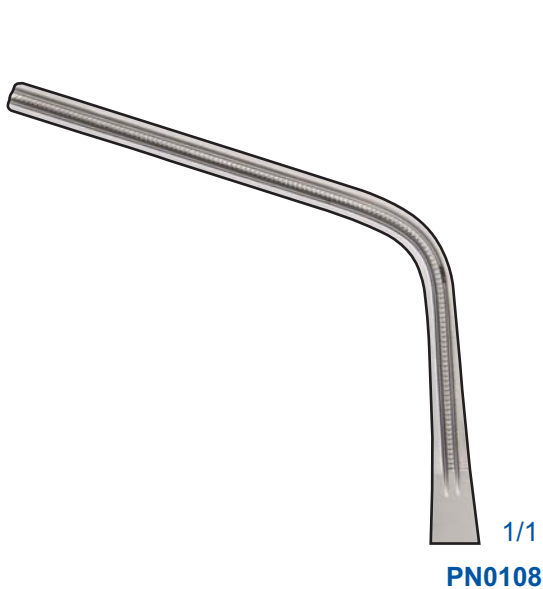

PN0108



PN0109

CODE	DESCRIPTION	LENGTH	JAW LENGTH	TEETH
PN0108	Hayes Colon Resection Clamp	270	80	DeBakey 1 x 2
PN0109	Hayes Colon Resection Clamp	285	100	DeBakey 1 x 2



PN0028



1/1

PN0028

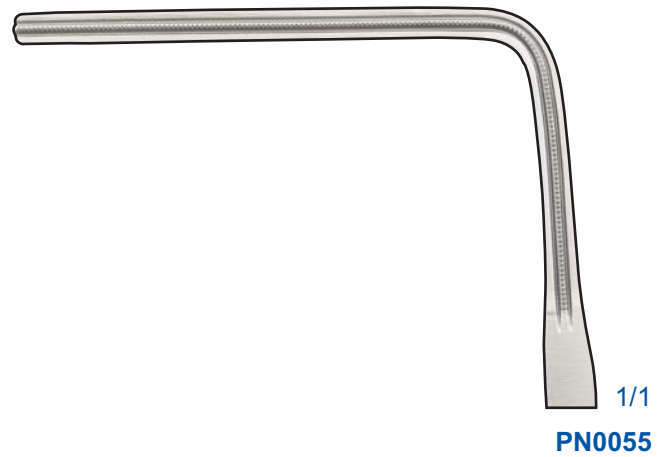

1/1

PN0055

CODE	DESCRIPTION	LENGTH	JAW LENGTH	TEETH
PN0028	Goldberg Anterior Resection Clamp	335	75	Debakey 1 x 2
PN0055	Goldberg Anterior Resection Clamp	340	85	Debakey 1 x 2

McDOUGALL PROSTATECTOMY CLAMP



PN0298

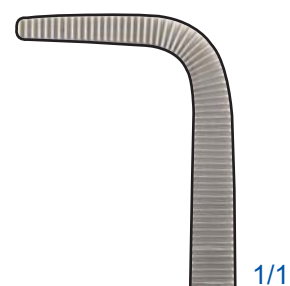

PN0297

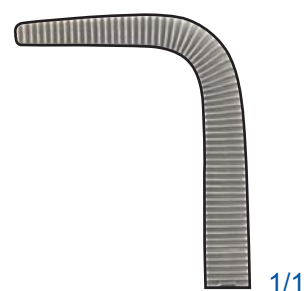

CODE	DESCRIPTION	LENGTH	JAW LENGTH	TEETH
PN0298	McDougall Prostatectomy Clamp, Left	255	40	Lateral
PN0297	McDougall Prostatectomy Clamp, Right	255	40	Lateral